

Installation instructions for CH150 Rings Suspension

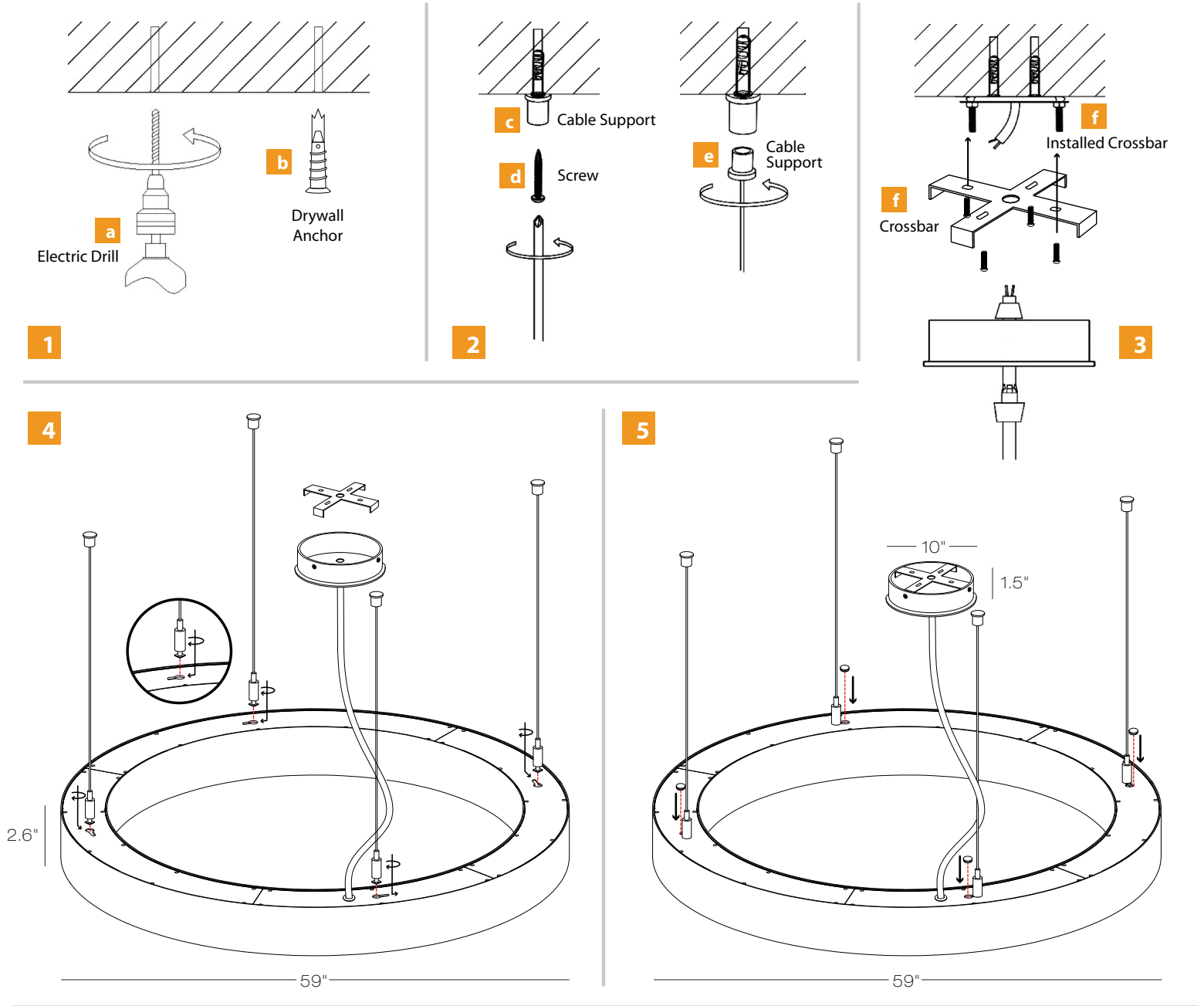

- 1** Lay ring on the floor below the install location. Using a plumb bob, or plumb spot laser, mark each mounting hole position on the ceiling.
- 2** Drill 1/16" pilot holes at marked hole positions. Install drywall or other anchors where appropriate, then install cable supports at drilled locations.
- 3** Install crossbar onto junction box.
- 4** Connect included metal cable to the ceiling cable supports. Measure hanging height, then attach cable to the fixture. Make final height adjustments as necessary.
- 5** With the fixture securely suspended by cable supports, shorten the power cord to reduce slack and neatly coil excess cord into the canopy.
- 6** Connect driver wires to building power and attach canopy to the crossbar.
- 7** Test fixture.

SAVE THIS INSTRUCTIONS

