

**MONORAIL**

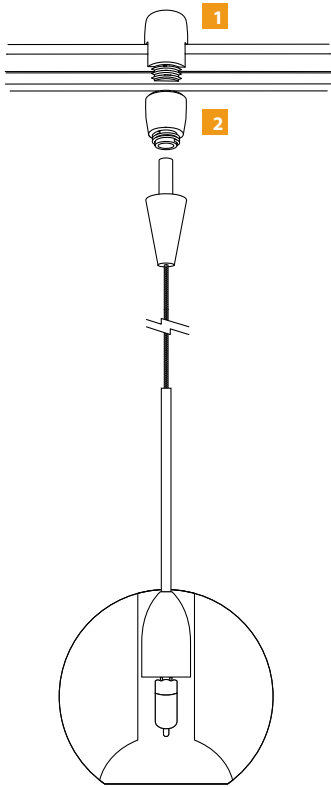

- 1** Monorail Adapter place "U" grooved part with male threads over monorail.
- 2** Raise bottom of monorail adapter with female threads mating with "U" part male threads.
- 3** Rotate clockwise till tight.
- 4** Be careful not to cross-thread when tightening.

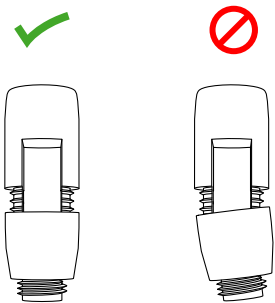

**CABLE**

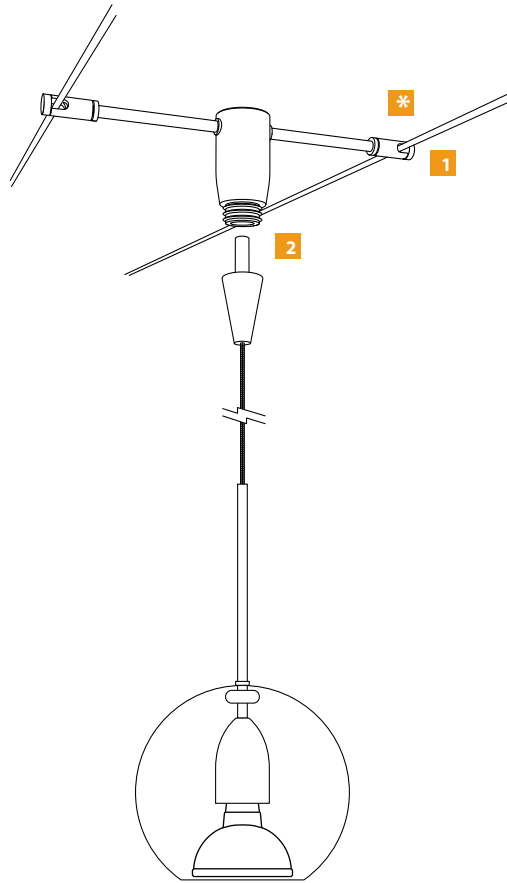

- 1** Strip insulated Cable aprox. 1/4" with sharp knife, make sure to not cut cable metal stranding, install EZ Jack Cable Adapter by loosening thumb screws, removing them. Place adapter ends over the stripped cable area, tighten thumbscrews into their threaded holes.
- 2** Raise pendant to mate with male threads, rotate clockwise till tight. Be careful not to cross-thread when tightening.

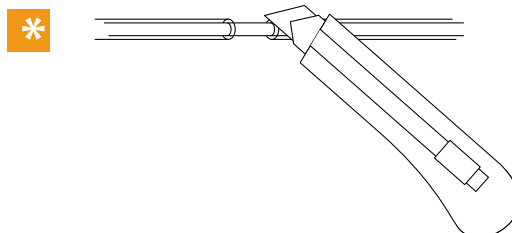

**MONOPOINT**

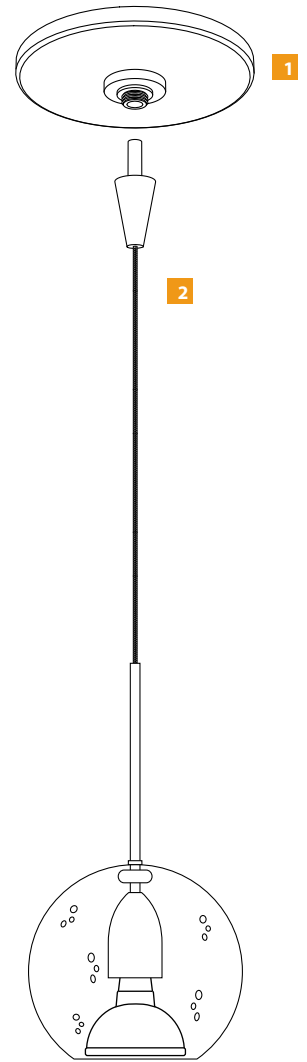

- 1** Mount monopoint canopy per enclosed instructions.
- 2** Raise pendant to mate with male threads, rotate clockwise till tight. Be careful not to cross-thread when tightening.

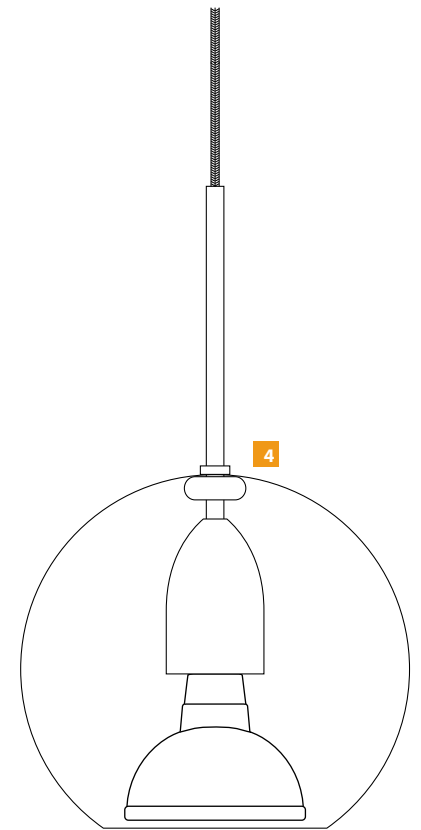
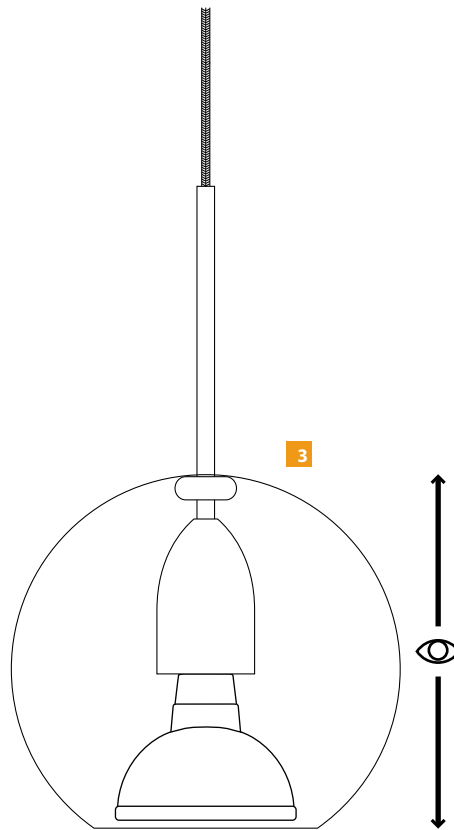
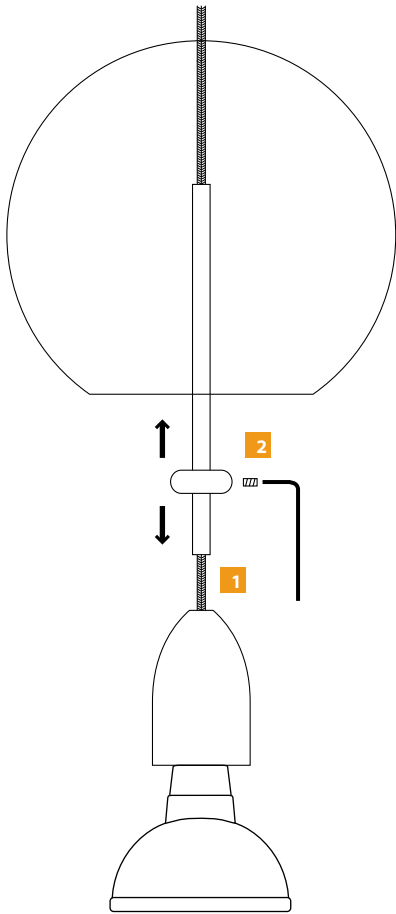

**1** Insert coaxial cable through stem as shown.

**2** adjustable ring with hex key set screw height should be adjusted with stem inserted into top of socket holder and MR16 installed.

**3** Height is determined by visually leveling bottom of MR16 with bottom of (PD116 or PD177 only).

**4** Finish top of glass with small flat washer.

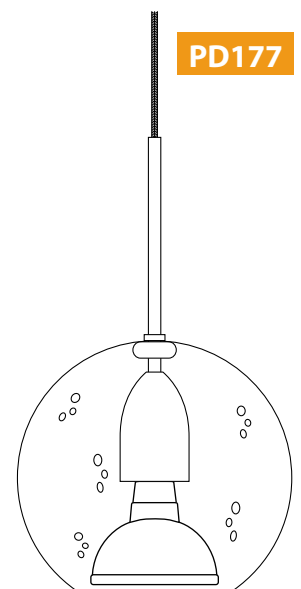
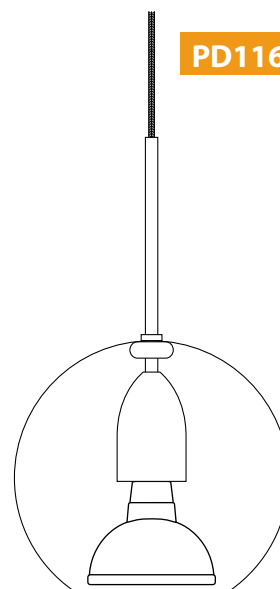
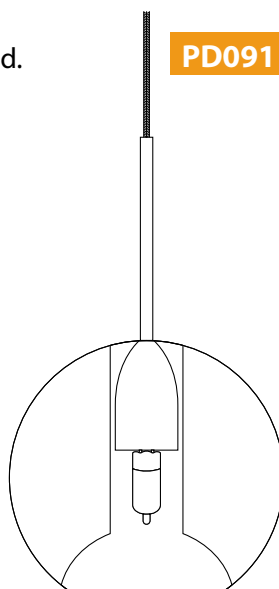

### ADJUST THE FIXTURE HEIGHT

- 1 Cut the coaxial cable to the desired length with a sharp cutter. The overall fixture height (H) is measured from bottom of the glass shade to end of the coaxial cable.

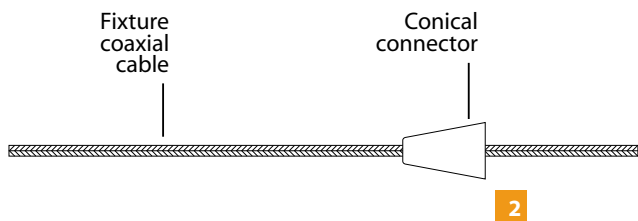
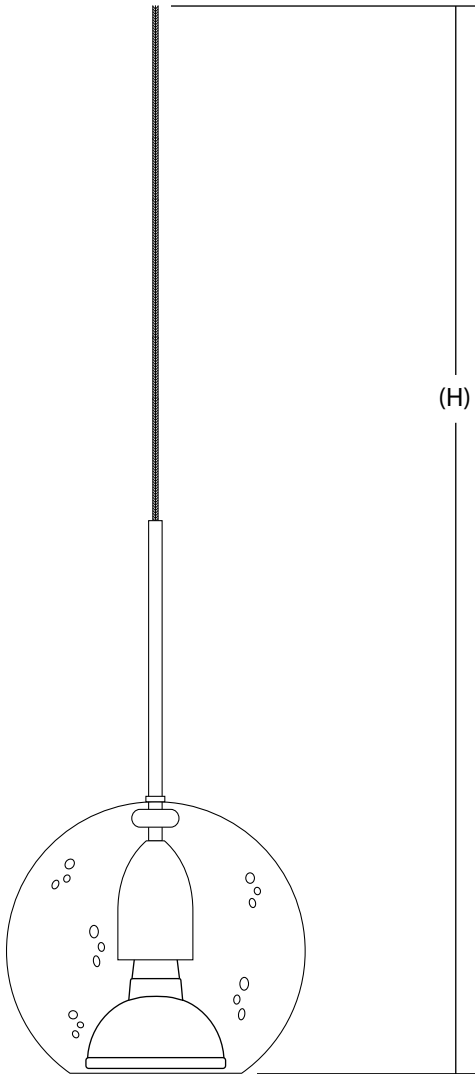

- 2 Insert the fixture coaxial cable through the conical connector



- 3 Insert the coaxial cable through the flared end of the strain relief.

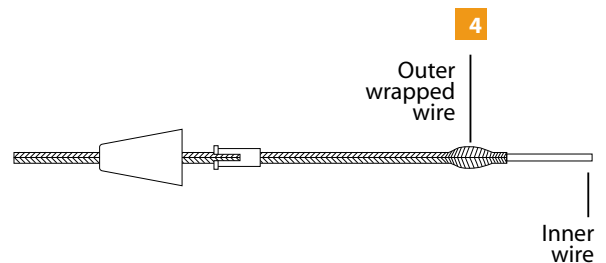

- 4 Slide the outer wrapped wire back to expose the inner wire.

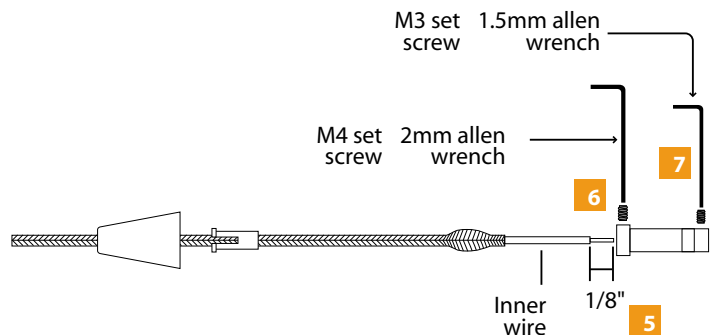

- 5 Strip 1/8" from end of the inner wire. Make sure that the stripped portion is not greater than 3/16".
- 6 Loosen (Do Not Remove) the M4 set screw with the provided 2mm Allen wrench.
- 7 Remove the M3 set screw with the provided 1.5mm Allen wrench.

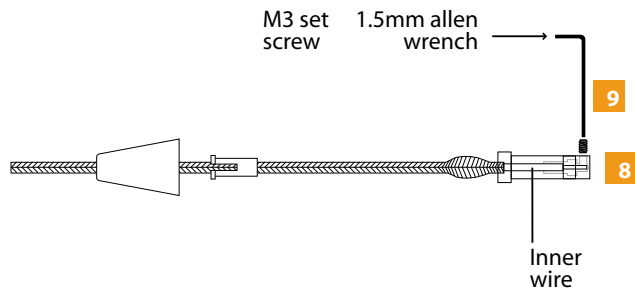

- 8 While inserting the inner wire into the connector look through the set screw hole to make sure that the stripped portion of the inner wire contacts end of the connector.
- 9 Hold the coaxial cable in place; replace and tighten the M3 set screw with the 1.5MM Allen wrench. Lightly tug on the coaxial cable to make sure that the set screw connection is tight.

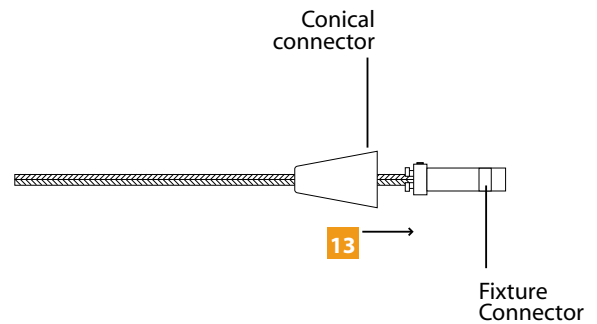

- 13 Slide the conical connector over the fixture connector.

To install the fixture, refer to the instructions provided with the system.

**SAVE THESE INSTRUCTIONS**

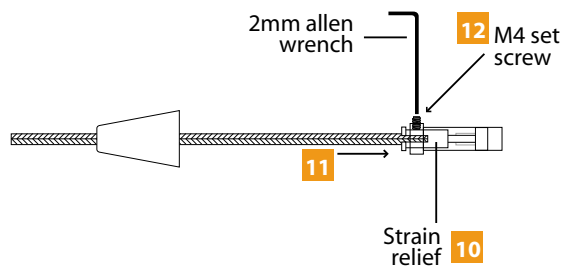

- 10 The strain relief slots should be rotated 90° away from the M4 set screw.
- 11 Slide and push the strain relief completely into the connector. This will force the outer wrapped wire to be inserted into the connector.
- 12 Tighten the M4 set screw with the 2mm allen wrench so that the strain relief holds the outer wrapped wire in place.

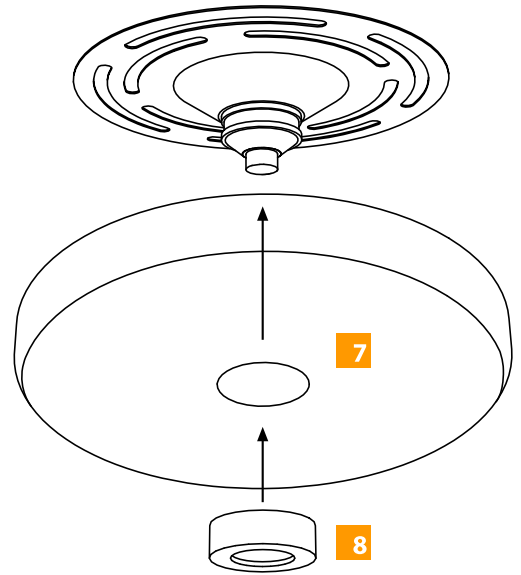
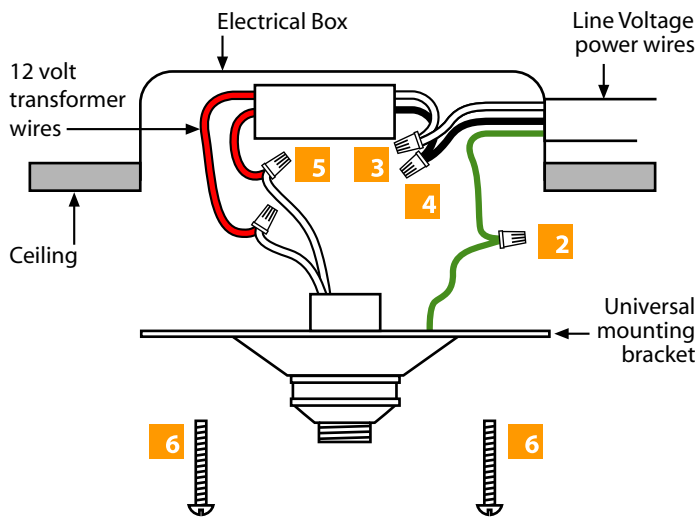

COMPONENTS INCLUDED IN CANOPY KIT

- 1** Turn power off at electrical box.
- 2** Ground the universal mounting bracket to junction box and transformer wire.
- 3** Connect the black and white wires of transformer to the hot and neutral wires in Jbox.
- 4** Insert transformer into Jbox.
- 5** Connect secondary low voltage wires of transformer to universal mounting bracket connector wires.
- 6** Position universal mounting bracket toward Jbox and secure universal mounting bracket directly to Jbox using screws from accesory bag.
- 7** Slide decorative canopy cover over universal mounting bracket and secure canopy to universal mounting bracket using threaded decorative collar ring.
- 8** Place the canopy cover over the universal mounting bracket and screw cap onto the threaded universal mounting bracket post.

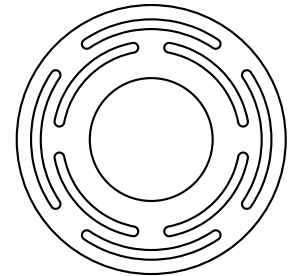

Universal Mounting Bracket

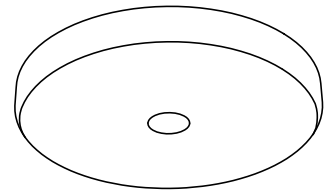

Canopy

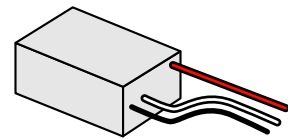

Transformer

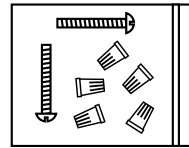

Accesory bag

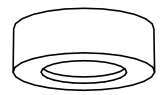

Collar Ring