



13 Light EZ Jack Canopy

12VAC electronic transformer(s) included based on Halogen or LED selection, contact Customer Service for custom configurations.

Canopy includes female EZ Jack ports only. Male EZ Jack pendant adapters are included with all compatible Stone Lighting low voltage pendants, or they can be purchased separately under part number MSEZJCK.

Model
CPEJRN13

24 24" diameter

Finish	Dimensions	Lamp
SN	24	LED

PN polished nickel
SN satin nickel
WH white

LED LED fixtures
HAL Halogen fixtures

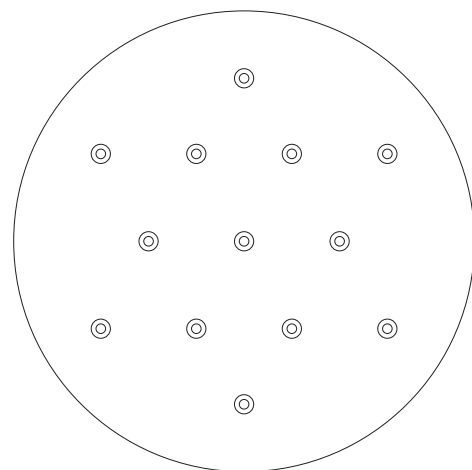

24" Ø



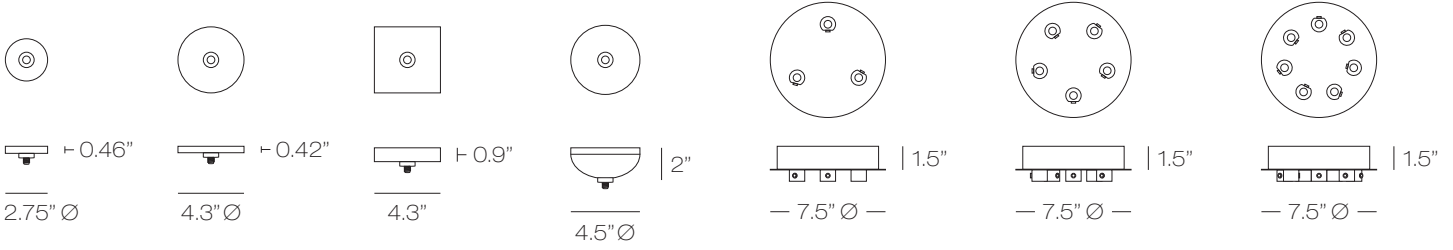

CPEJRN2(F)(L) 1 Light **CPEJRN1(F)(L)** 1 Light **CPEJSQ1(F)(L)** 1 Light **CPEJRN0(F)(L)** 1 Light **CPSRRN3(F)(L)** 3 Lights **CPSRRN5(F)(L)** 5 Lights **CPSRRN7(F)(L)** 7 Lights

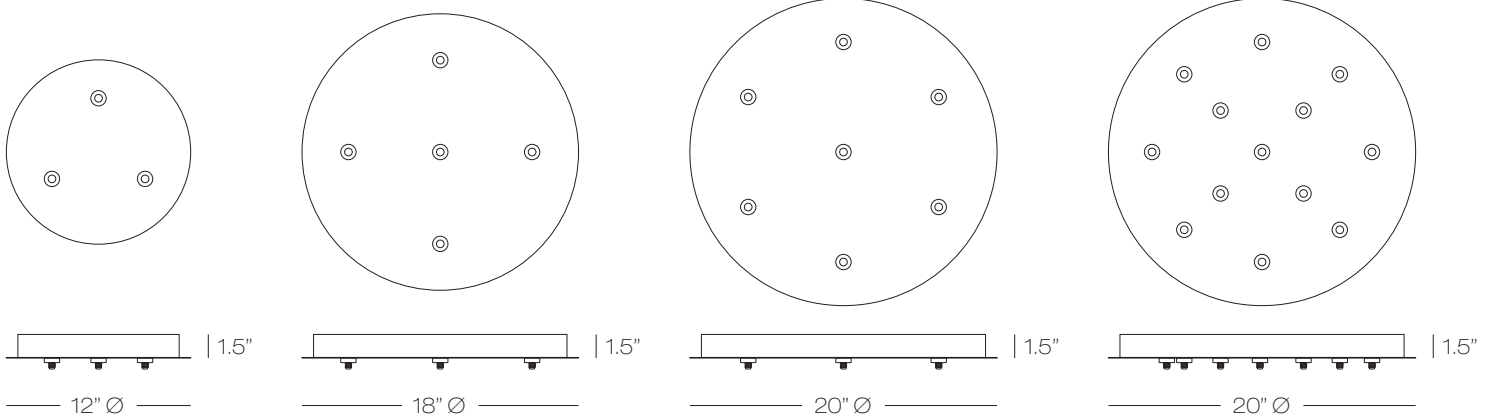

CPEJRN3(F)(L) 3 Lights **CPEJRN5(F)(L)** 5 Lights **CPEJRN7(F)(L)** 7 Lights **CPEJRN13(F)(L)** 13 Lights

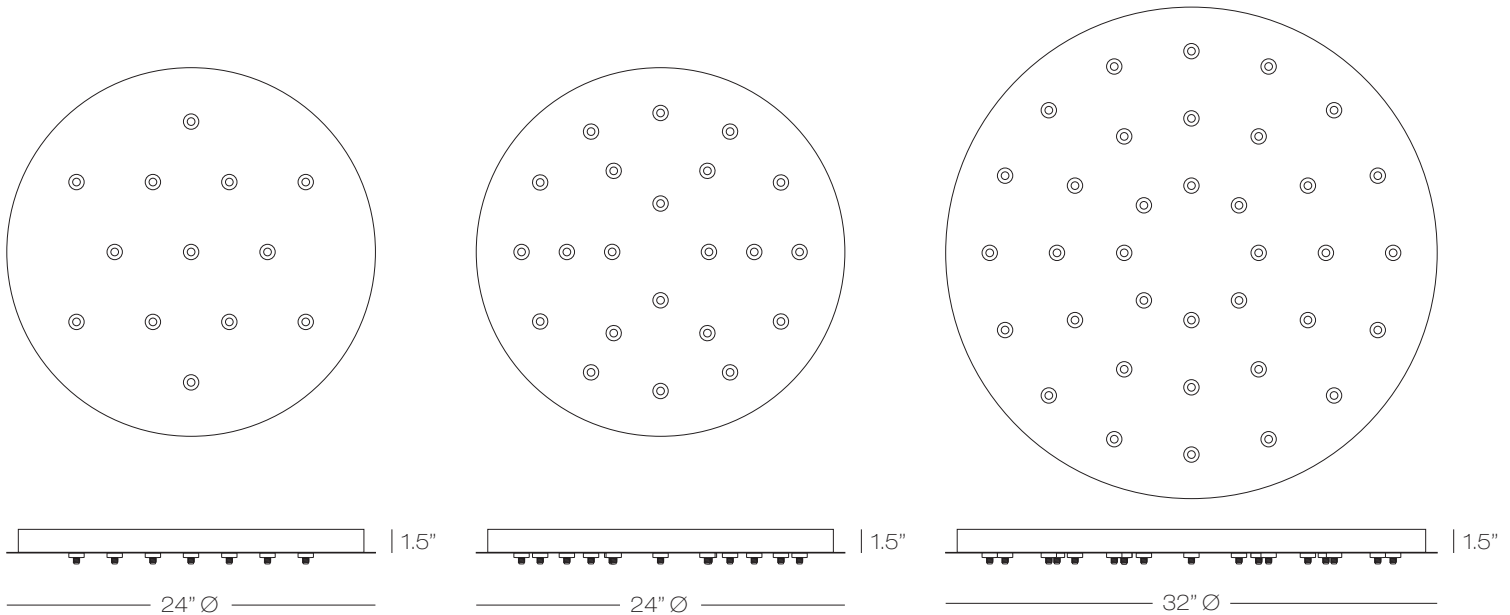

CPEJRN13(F)24(L) 13 Lights **CPEJRN22(F)24(L)** 22 Lights **CPEJRN36(F)32(L)** 36 Lights

F = Finish Option (BB, BL, BZ, PC, PN, SN, WH)
L = Lamp (LED, HAL)

LOW VOLTAGE CANOPIES COMPARISON
Round, Square and Rectangular Canopies

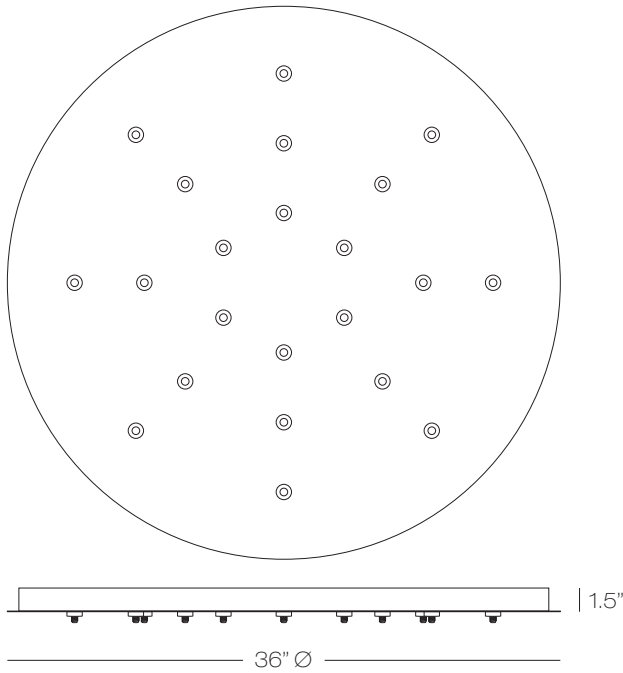

CPEJRN22(F)36(L) 22 Lights

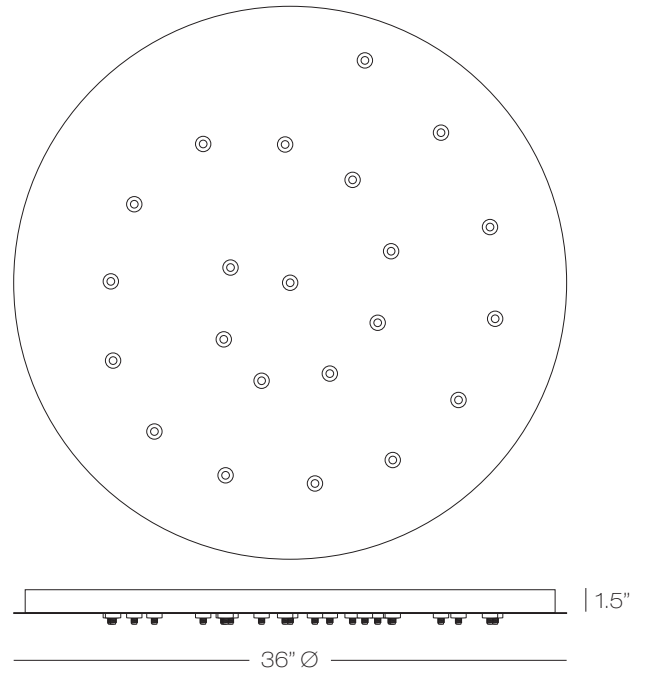

CPEJRN22S(F)36(L) 22 Lights

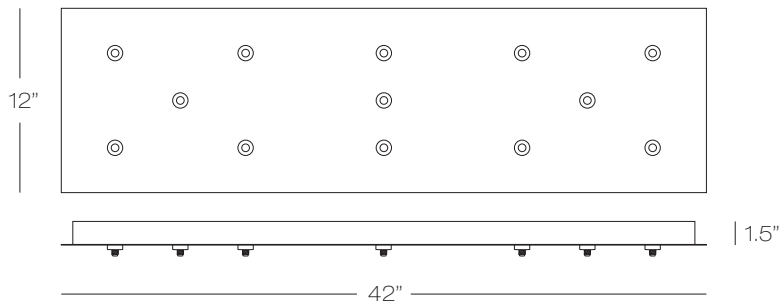

CPEJRT7MR6(F)1242(L) 13 Lights

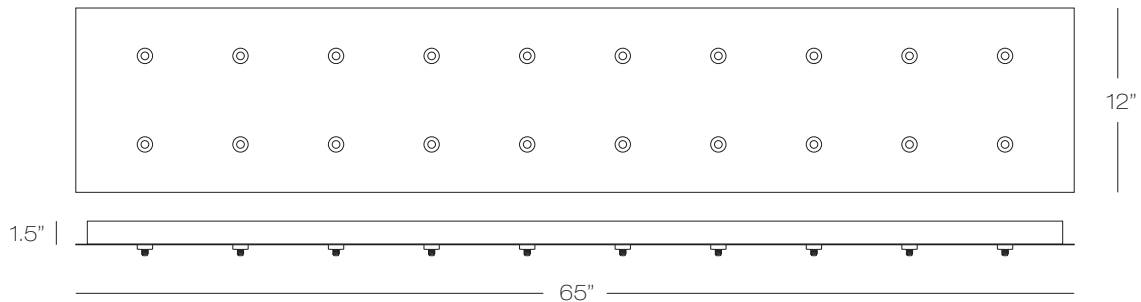

CPEJRT20(F)1265(L) 20 Lights

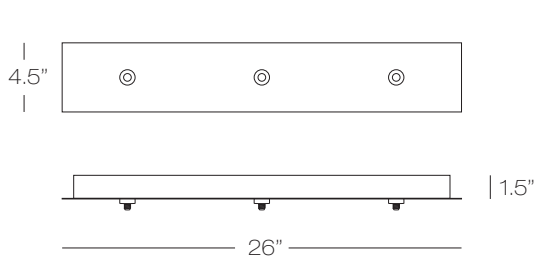

CPEJRT3(F)(L) 3 Lights

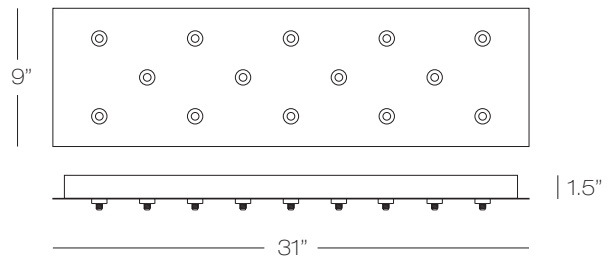

CPEJRT14(F)(L) 14 Lights

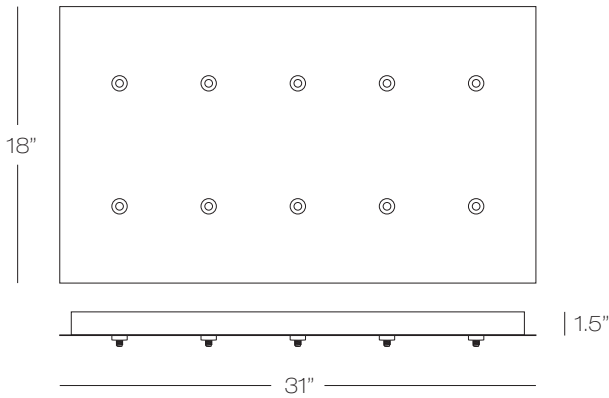

CPEJRT10(F)1831(L) 10 Lights

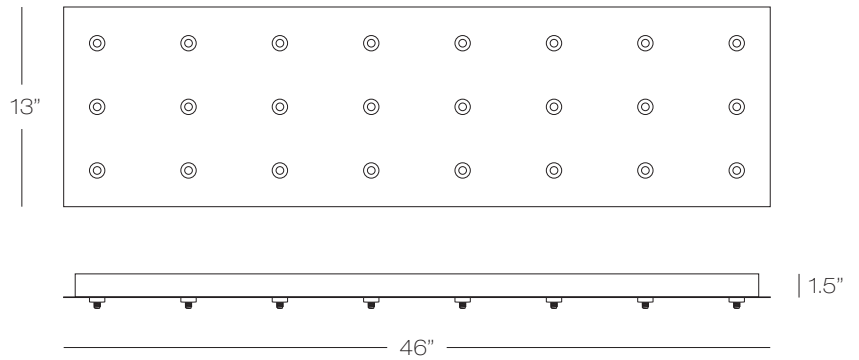

CPEJRT24(F)1346(L) 24 Lights

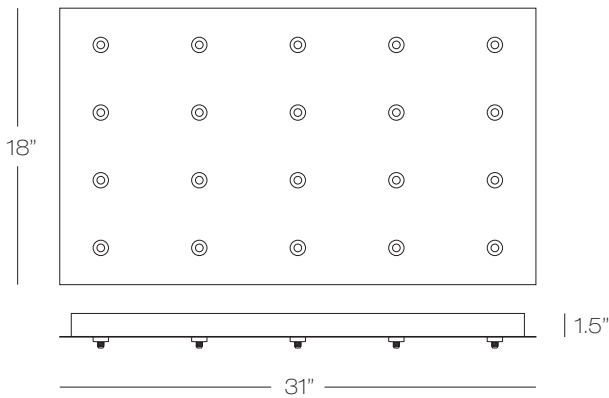

CPEJRT20(F)1831(L) 20 Lights

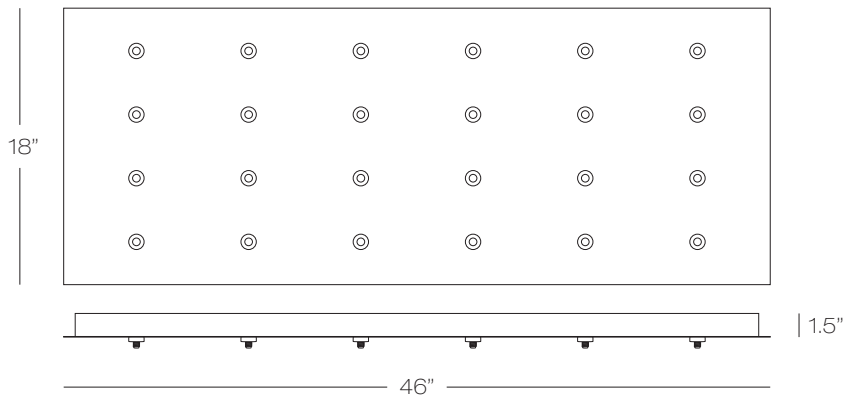

CPEJRT24(F)1846(L) 24 Lights

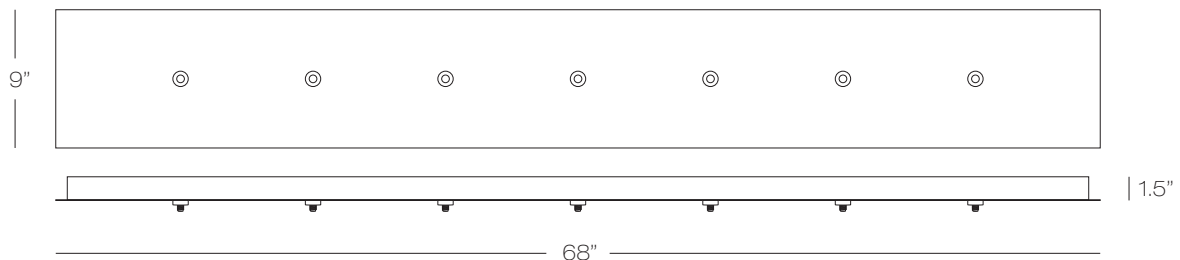

CPEJRT7(F)968(L) 7 Lights

F = Finish Option (BB, BL, BZ, PC, PN, SN, WH)
L = Lamp (LED, HAL)

LOW VOLTAGE CANOPIES COMPARISON
Round, Square and Rectangular Canopies

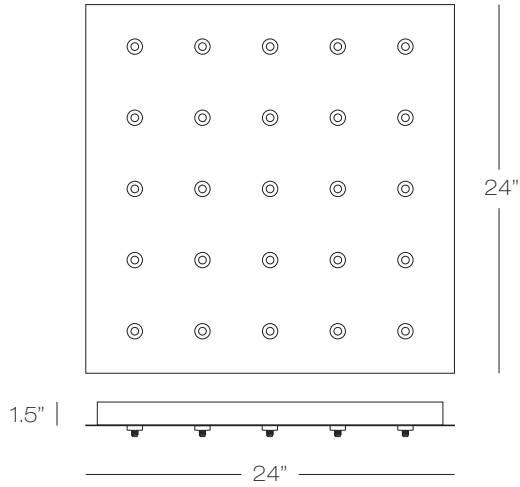

CPEJSQ25(F)(L) 25 Lights

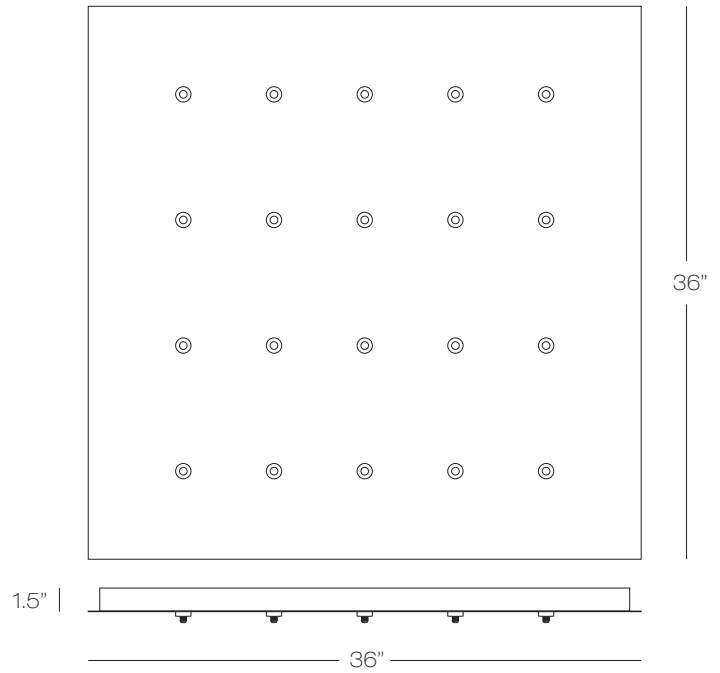

CPEJSQ20(F)3636(L) 20 Lights

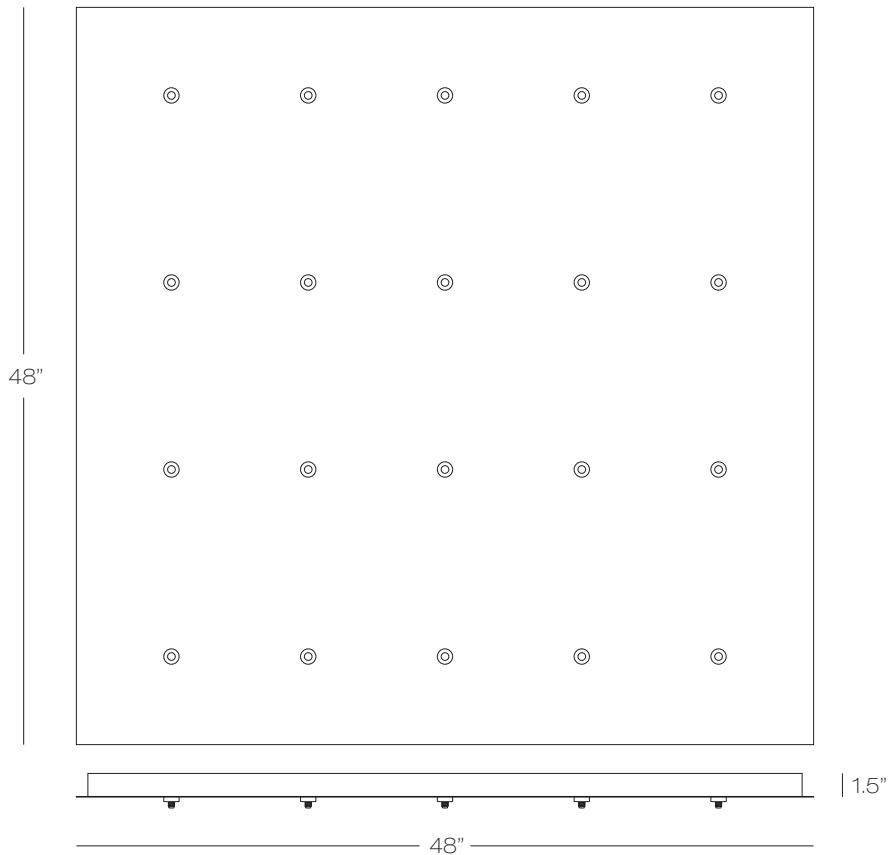

CPEJSQ20(F)4848(L) 20 Lights

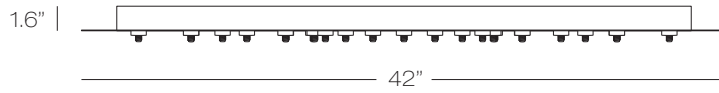
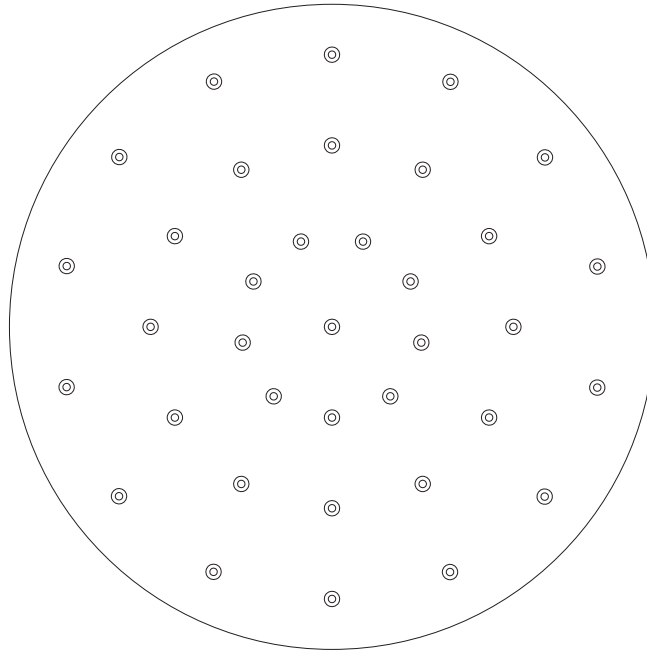

CPEJRN36(F)42(L) 36 Lights

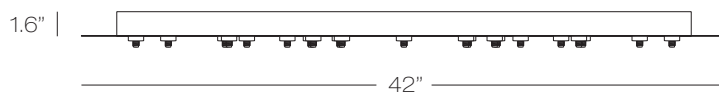
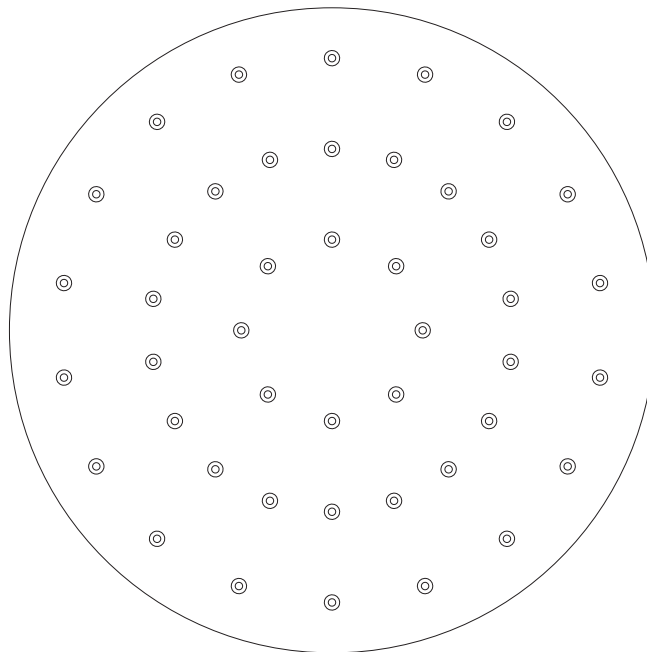

CPEJRN45(F)42(L) 36 Lights